

THIS DOCUMENT CONTAINS PROPRIETARY INFORMATION AND IS SUBMITTED IN CONFIDENCE. THIS DOCUMENT IS SUBJECT TO RETURN UPON REQUEST. THE INFORMATION CONTAINED HEREIN IS NOT BE USED IN ANY WAY DERIMENTAL TO THE INTERESTS OF HYPOWER.

NOTE: PIN HOLE CLEARANCE MACHINED TO SUIT ANSI B4.2 D9/h9  
 PORT THREADS MACHINED TO ISO11926-1 OTHER THREADS MACHINED TO CLASS 2A/B  
 GENERAL DIMENSIONS SUIT ISO2768-mK UNLESS OTHERWISE STATED  
 GENERAL SURFACE MACHINING TO ISO1302  
 FORCE CALCULATIONS ARE THEORETICAL MAXIMUM. ALLOW UP TO 20% FOR LOSSES  
 ROD MOUNTING CONDITIONS AFFECT ROD BUCKLING SAFETY FACTOR

**OPERATING CONDITIONS**

MAX PRESSURE	210 BAR
PUSH FORCE @ 210 BAR	2393 Kg
PULL FORCE @ 210 BAR	1329 Kg
FLUID	HYDRAULIC OIL VG46

**CYLINDER FACTOR OF SAFETY AT 210 BAR**

STRESS AREA	SAFETY FACTOR	COMMENT
PISTON PULL OFF	4.46:1	
ROD MOUNT PULL OFF	5.71:1	
ROD BUCKLE	12.2:1	AT MAX EXTENSION
BASE MOUNT	6:1	
ROD MOUNT	4.27:1	
BARREL	6.25:1	HOOP STRESS

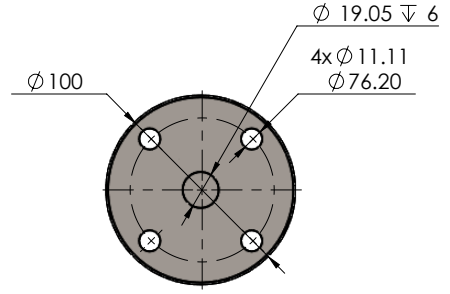
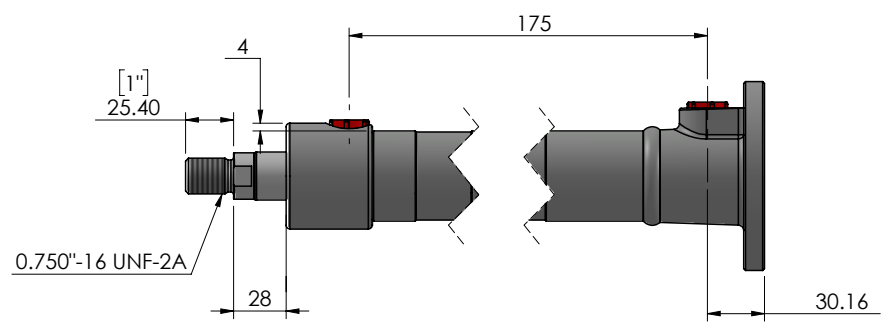
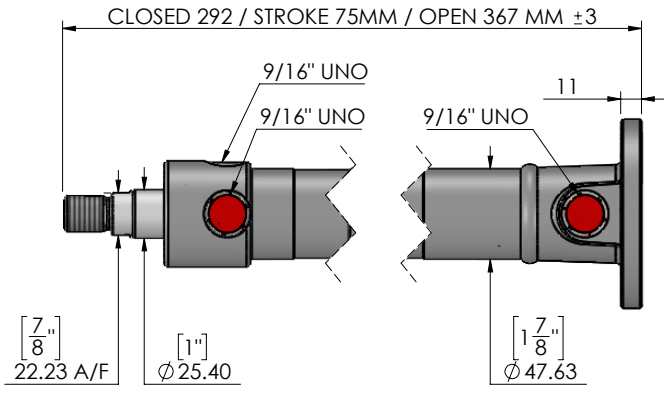

**CYLINDER SPECIFICATIONS**

PARAMETER	VALUE	PARAMETER	VALUE
CLOSED	292 MM	PORTS	9/16" UNO
STROKE	75 mm	BARREL	1.5" TUBE 0.1875" WALL
OPEN	367 MM	HEAD CAP	R10121
STAND OUT	28 MM	ROD CAP	FC0015401002
ROD	1.00" - K1045	WEIGHT	3.6 Kg
BORE	1.50"	PAINTING	REFER TO QUOTE

CLIENT SIGNATURE			
APPROVAL DATE			
B		SHEET SIZE	A4
A		SCALE	1:4
0		SHEET OF	1/1
REV	DATE	DRAWN CHECKED	REMARK



**CFH 15**

DESCRIPTION	
CFC 1.50" BORE X 0075MM STROKE X 1.00" ROD-9/16UNO	
PART NO.	DWG NO.
CFC150075AA100	CFC150075AA100DIM