

THIS DOCUMENT CONTAINS PROPRIETARY INFORMATION AND IS SUBMITTED IN CONFIDENCE. THIS DOCUMENT IS SUBJECT TO RETURN UPON REQUEST. THE INFORMATION CONTAINED HEREIN IS NOT BE USED IN ANY WAY DERIMENTAL TO THE INTERESTS OF HYPOWER.

NOTE: PIN HOLE CLEARANCE MACHINED TO SUIT ANSI B4.2 D9/h9
 PORT THREADS MACHINED TO ISO11926-1 OTHER THREADS MACHINED TO CLASS 2A/B
 GENERAL DIMENSIONS SUIT ISO2768-mK UNLESS OTHERWISE STATED
 GENERAL SURFACE MACHINING TO ISO1302
 FORCE CALCULATIONS ARE THEORETICAL MAXIMUM. ALLOW UP TO 20% FOR LOSSES
 ROD MOUNTING CONDITIONS AFFECT ROD BUCKLING SAFETY FACTOR

OPERATING CONDITIONS

MAX PRESSURE	210 BAR
PUSH FORCE @ 210 BAR	2393 Kg
PULL FORCE @ 210 BAR	1329 Kg
FLUID	HYDRAULIC OIL VG46

CYLINDER FACTOR OF SAFETY AT 210 BAR

STRESS AREA	SAFETY FACTOR	COMMENT
PISTON PULL OFF	4.46:1	
ROD MOUNT PULL OFF	5.71:1	
ROD BUCKLE	8.3:1	AT MAX EXTENSION
BASE MOUNT	6:1	
ROD MOUNT	4.27:1	
BARREL	6.25:1	HOOP STRESS

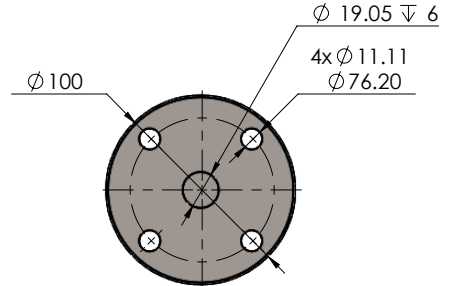
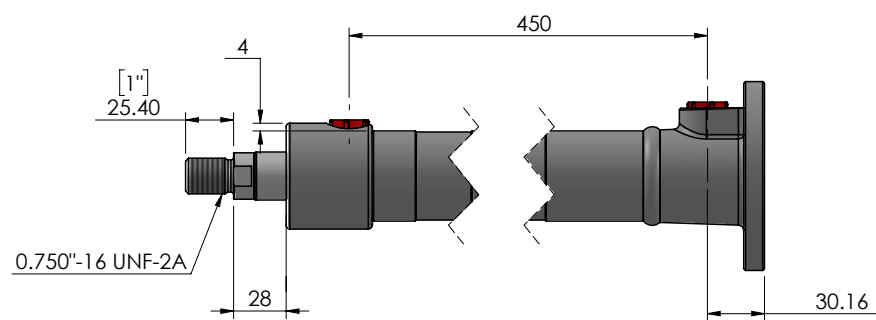
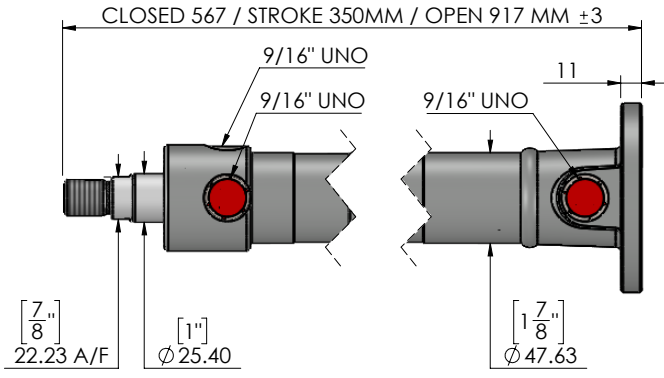

CYLINDER SPECIFICATIONS

	1	2	3	4
CLOSED	567 MM	PORTS	9/16" UNO	
STROKE	350 mm	BARREL	1.5" TUBE 0.1875" WALL	
OPEN	917 MM	HEAD CAP	R10121	
STAND OUT	28 MM	ROD CAP	FC0015401002	
ROD	1.00" - K1045	WEIGHT	6.6 Kg	
BORE	1.50"	PAINTING	REFER TO QUOTE	

CLIENT SIGNATURE			
APPROVAL DATE			
B		SHEET SIZE	A4
A		SCALE	1:4
0		SHEET OF	1/1
REV	DATE	DRAWN CHECKED	REMARK



CFH 15

DESCRIPTION	
CFC 1.50" BORE X 0350MM STROKE X 1.00" ROD-9/16UNO	
PART NO.	DWG NO.
CFC150350AA100	CFC150350AA100DIM