

THIS DOCUMENT CONTAINS PROPRIETARY INFORMATION AND IS SUBMITTED IN CONFIDENCE. THIS DOCUMENT IS SUBJECT TO RETURN UPON REQUEST. THE INFORMATION CONTAINED HEREIN IS NOT BE USED IN ANY WAY DERIMENTAL TO THE INTERESTS OF HYPower.

NOTE: PIN HOLE CLEARANCE MACHINED TO SUIT ANSI B4.2 D9/h9
 PORT THREADS MACHINED TO ISO11926-1 OTHER THREADS MACHINED TO CLASS 2A/B
 GENERAL DIMENSIONS SUIT ISO2768-mK UNLESS OTHERWISE STATED
 GENERAL SURFACE MACHINING TO ISO1302
 FORCE CALCULATIONS ARE THEORETICAL MAXIMUM. ALLOW UP TO 20% FOR LOSSES
 ROD MOUNTING CONDITIONS AFFECT ROD BUCKLING SAFETY FACTOR

OPERATING CONDITIONS	
MAX PRESSURE	210 BAR
PUSH FORCE @ 210 BAR	13000 Kg
PULL FORCE @ 210 BAR	9772 Kg
FLUID	HYDRAULIC OIL VG46

CYLINDER FACTOR OF SAFETY AT 210 BAR		
STRESS AREA	SAFETY FACTOR	COMMENT
PISTON PULL OFF	1.17:1	
ROD MOUNT PULL OFF	3.41:1	
ROD BUCKLE	7.1:1	AT MAX EXTENSION
BASE MOUNT	3.43:1	
ROD MOUNT	4.4:1	
BARREL	3.57:1	HOOP STRESS

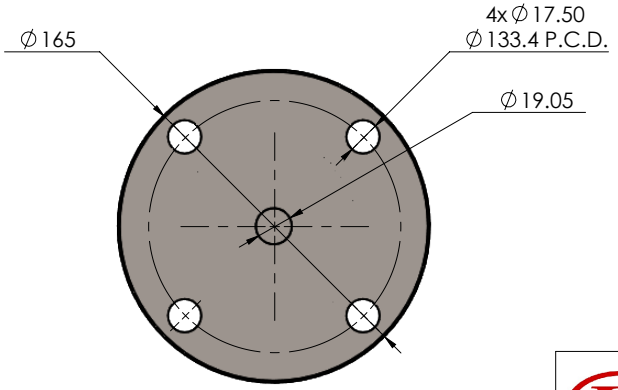
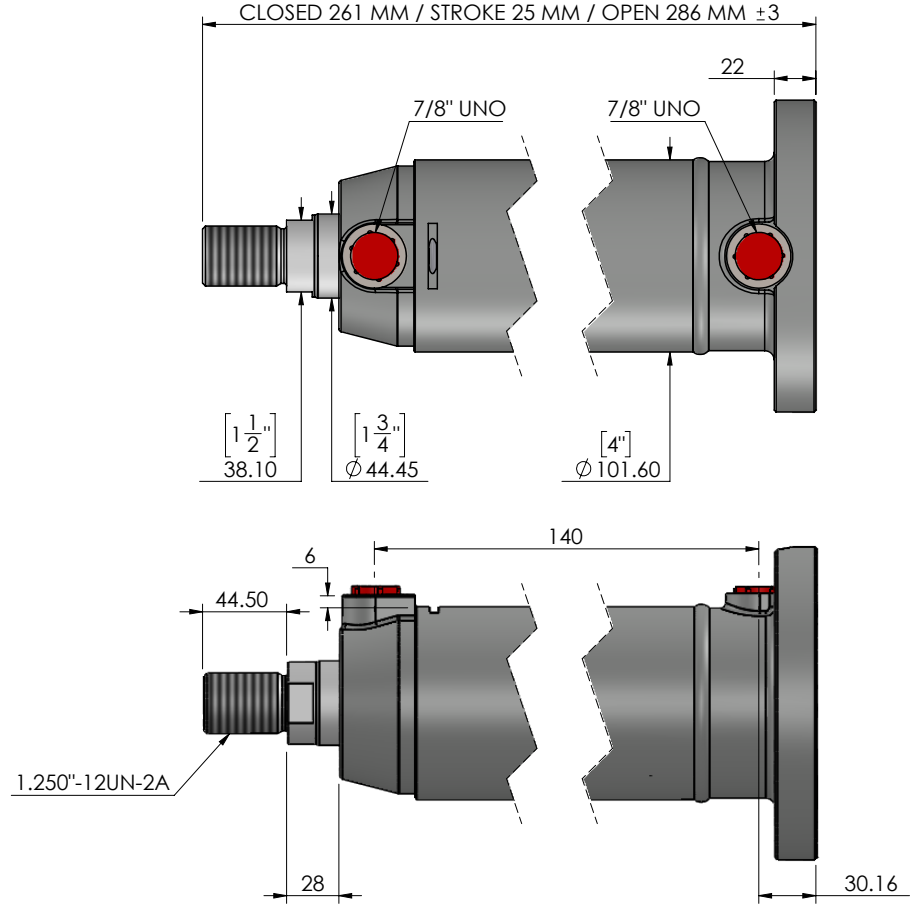

CYLINDER SPECIFICATIONS

CLOSED	261 MM	PORTS	7/8" UNO
STROKE	25 MM	BARREL	3.5" TUBE 1/4" WALL
OPEN	286 MM	HEAD CAP	R10125
STAND OUT	28 MM	ROD CAP	455120PA
ROD	1.75" - K1045	WEIGHT	10.5 Kg
BORE	3.50"	PAINTING	REFER TO QUOTE

CLIENT SIGNATURE			
APPROVAL DATE			
B		SHEET SIZE	A4
A		SCALE	1:4
0		SHEET OF	1/1
REV	DATE	DRAWN CHECKED	REMARK



CFC 35

DESCRIPTION	
CFC 3.50" BORE X 25MM STROKE X 1.75ROD-7/8UNO	
PART NO.	DWG NO.
CFC350025AC175	CFC350025AC175DIM