

THIS DOCUMENT CONTAINS PROPRIETARY INFORMATION AND IS SUBMITTED IN CONFIDENCE. THIS DOCUMENT IS SUBJECT TO RETURN UPON REQUEST. THE INFORMATION CONTAINED HEREIN IS NOT BE USED IN ANY WAY DERIMENTAL TO THE INTERESTS OF HYPower.

NOTE: PIN HOLE CLEARANCE MACHINED TO SUIT ANSI B4.2 D9/h9
 PORT THREADS MACHINED TO ISO11926-1 OTHER THREADS MACHINED TO CLASS 2A/B
 GENERAL DIMENSIONS SUIT ISO2768-mK UNLESS OTHERWISE STATED
 GENERAL SURFACE MACHINING TO ISO1302
 FORCE CALCULATIONS ARE THEORETICAL MAXIMUM. ALLOW UP TO 20% FOR LOSSES

OPERATING CONDITIONS	
MAX PRESSURE	210 BAR
PUSH FORCE @ 210 BAR	2441kgf
PULL FORCE @ 210 BAR	1330kgf
FLUID	HYDRAULIC OIL VG46

CYLINDER FACTOR OF SAFETY AT 210 BAR		
STRESS AREA	SAFETY FACTOR	COMMENT
PISTON PULL OFF	5.6	
ROD MOUNT PULL OFF	3.5	
ROD BUCKLE	WARNING	AT MAX EXTENSION
BASE MOUNT	3.1	
ROD MOUNT	4.7	
BARREL	6.2	HOOP STRESS
PINS	4.5	

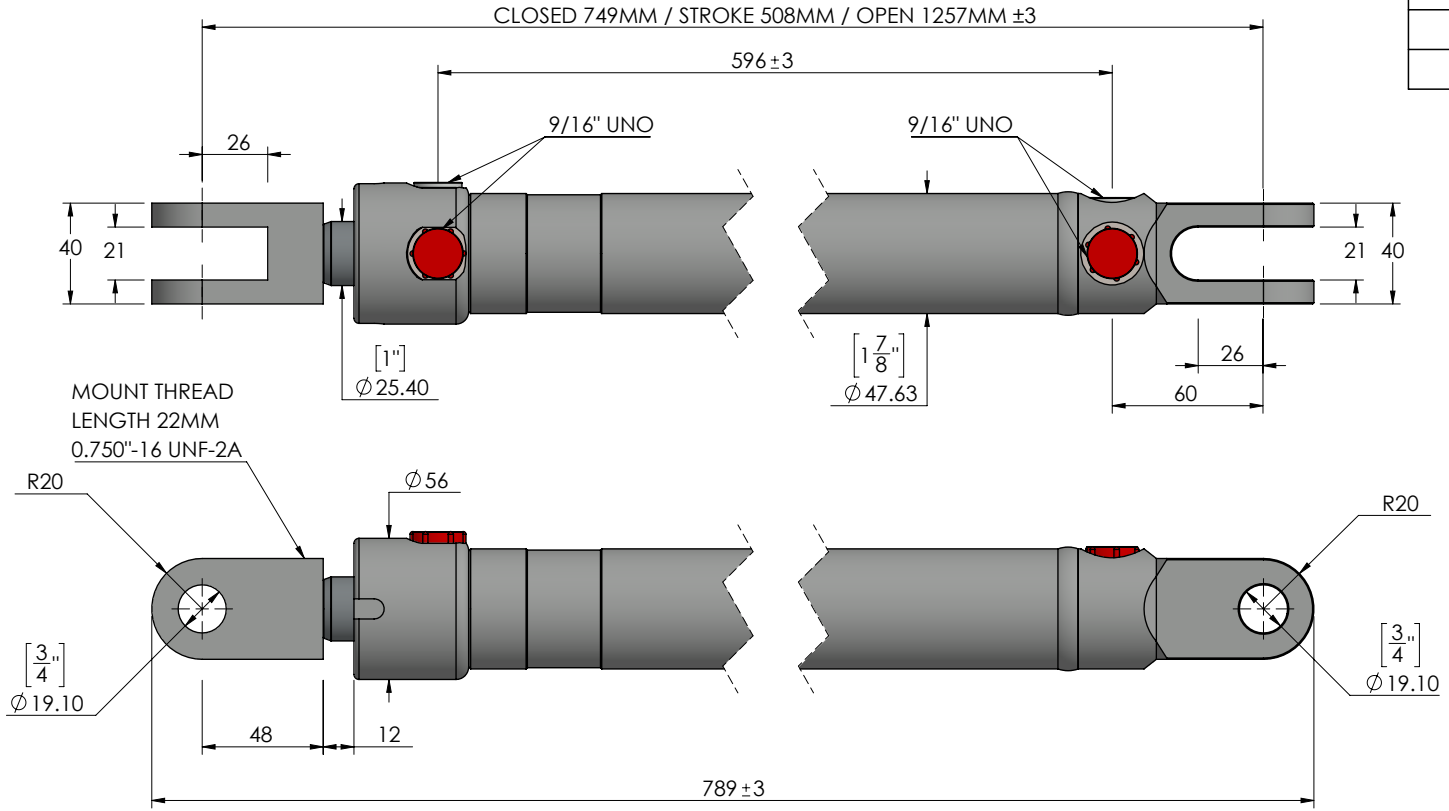

CYLINDER SPECIFICATIONS

CLOSED	749MM	PORTS	9/16" UNO
STROKE	508MM	BARREL	1.5" ID 3/16" TUBE WALL
OPEN	1257MM	HEAD CLEVIS	FC0015501001
STAND OUT	12MM	ROD CLEVIS	R10135
ROD	1.00 - K1045	WEIGHT	7.5Kg
BORE	1.5"	PAINTING	REFER TO QUOTE

CLIENT SIGNATURE			
APPROVAL DATE			
B		SHEET SIZE	A4
A		SCALE	1:3
0	8/10/2020	DW	
REV	DATE	DRAWN CHECKED	REMARK



HPAG 15

DESCRIPTION	
HPAG 1.5" BORE X 20"(508MM) X 1.00" ROD - DUAL PORTS	
PART NO.	DWG NO.
HPAG15200D100A	HPAG15200D100ADIM

